

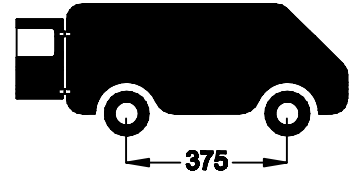

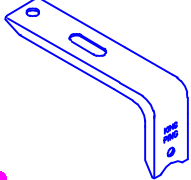

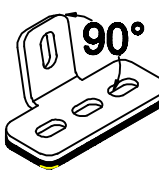

FORD TRANSIT 2014

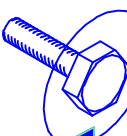
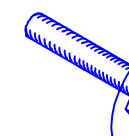

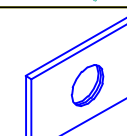
320x173 cm L3 H2

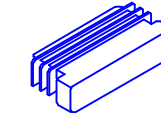
| | |
|--|--|
|  8x |  8x |
|  24x Max. 13Nm |  8x Max. 13Nm |
|  32x Max. 20Nm |  24x |
|  24x |  8x |
|  16x |  4x |

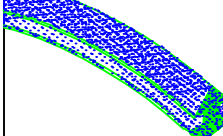
KING PING[®]
www.kingping.nl
info@kingping.nl

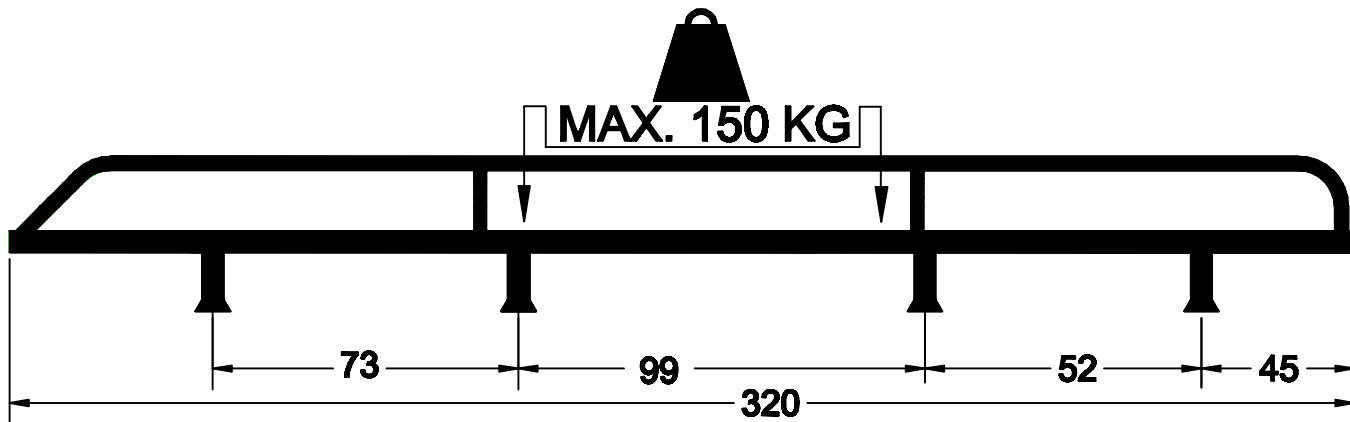
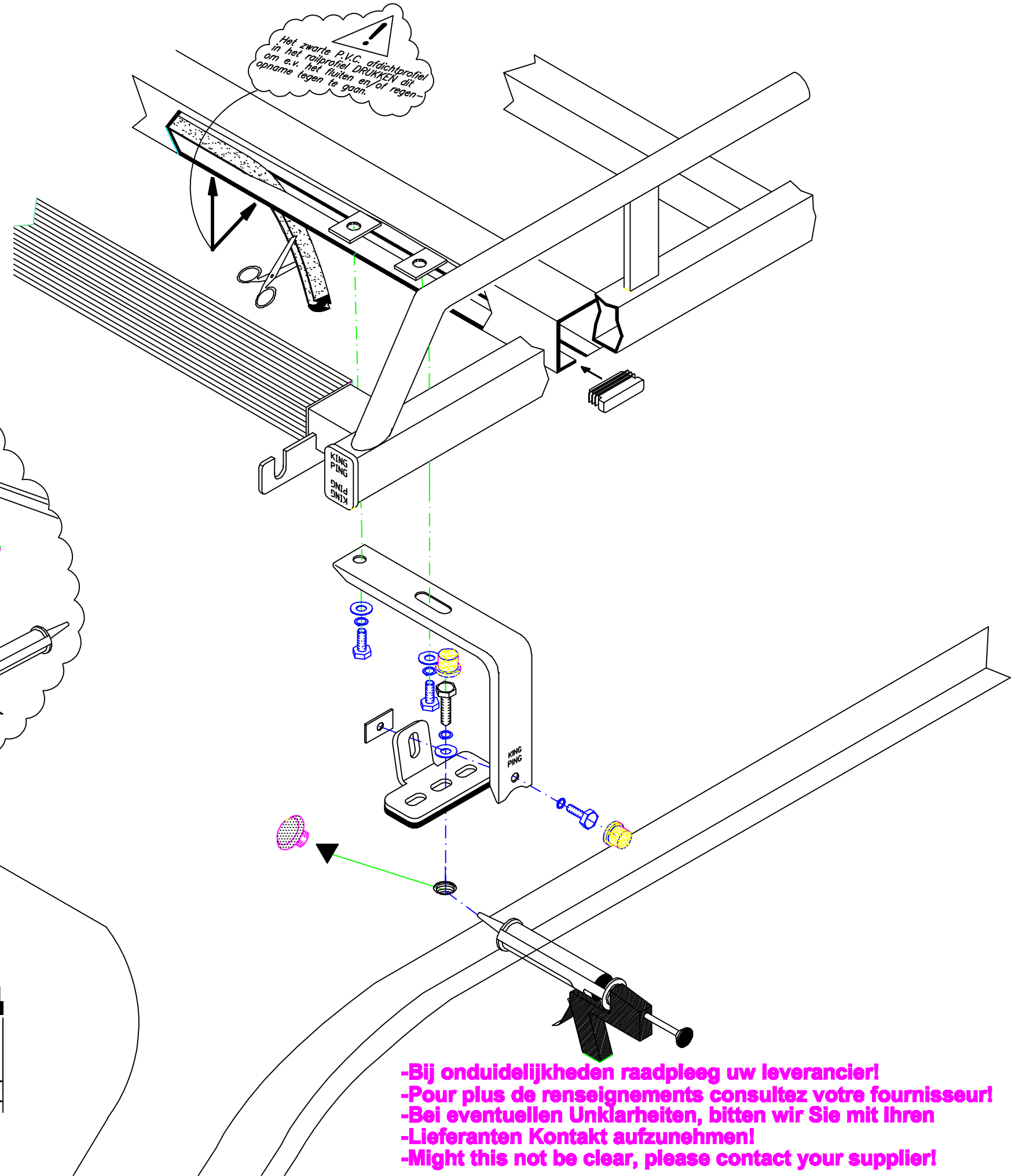

3211 FTL3H2 320173S 08/2017