

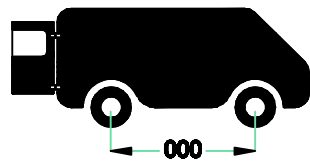

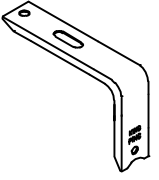

FORD TRANSIT 2014

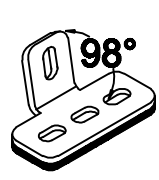
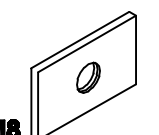
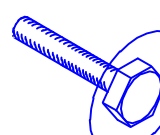

250x160 cm L2 H3

 6x	 6x
 18x	 6x 14 Nm Max. 20Nm
 24x	 18x 14 Nm
 18x	 6x
 3x	

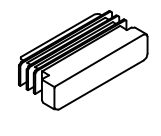
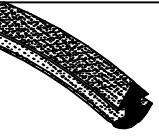
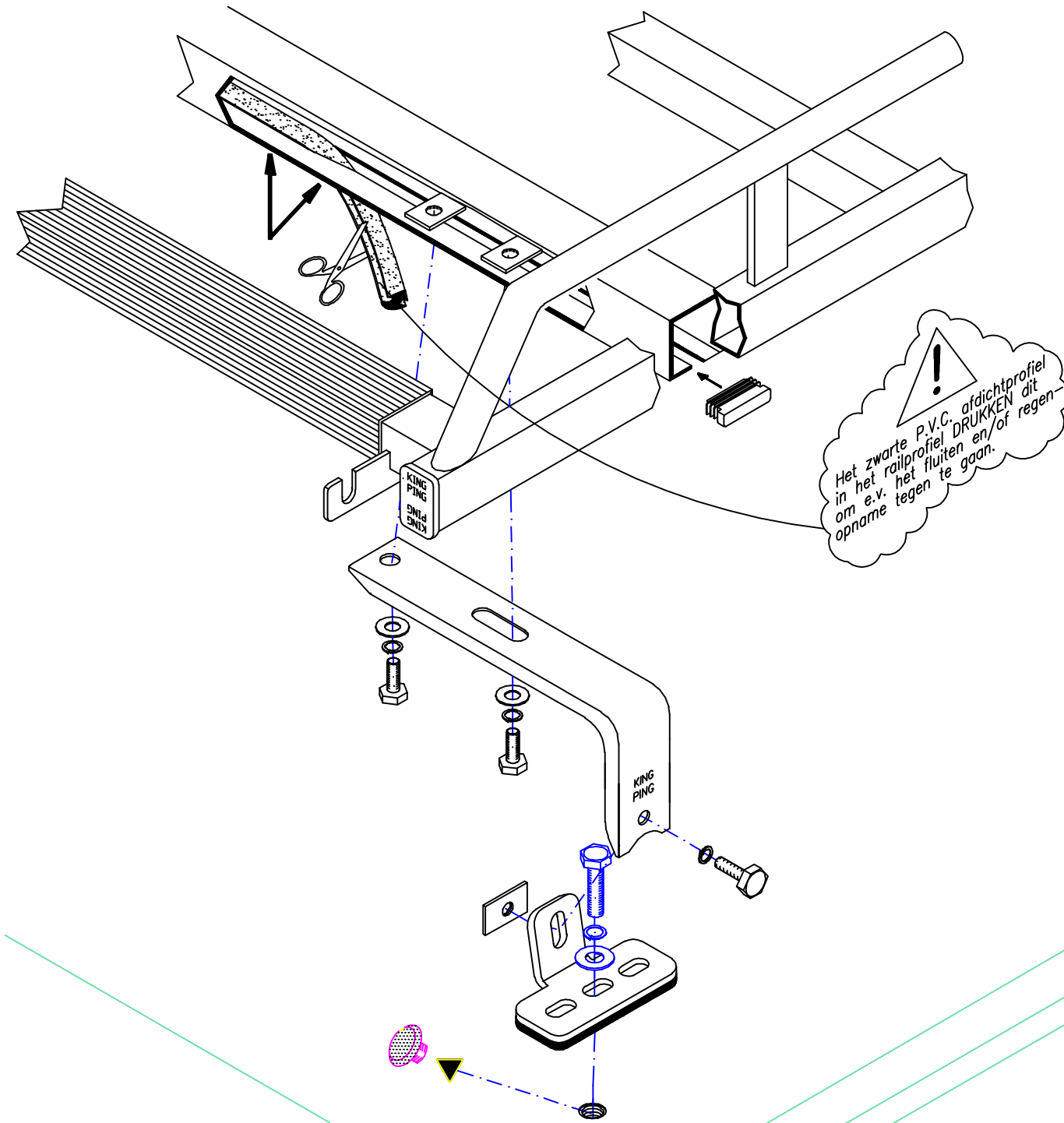

KING ALU www.kingping.nl
Email: info@kingping.nl

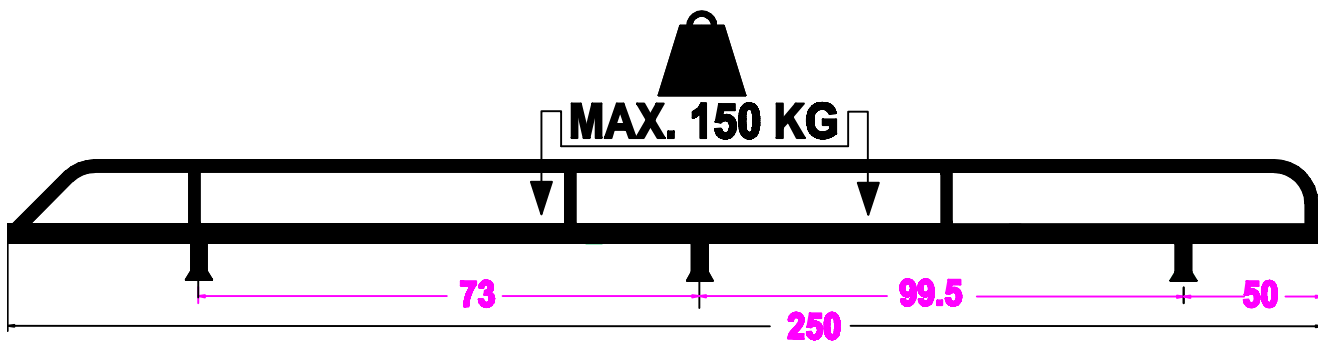

259 FTL2H3 250160S 08/2015

- Bij onduidelijkheden raadpleeg uw leverancier!
- Pour plus de renseignements consultez votre fournisseur!
- Bei eventuellen Unklarheiten, bitten wir Sie mit Ihren Lieferanten Kontakt aufzunehmen!
- Might this not be clear, please contact your supplier!