

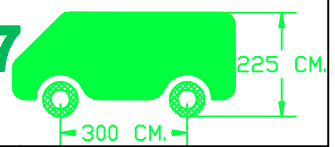

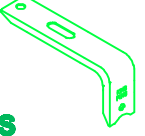

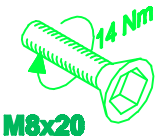



**Citroën Jumper 2007**  
**Fiat Ducato 2007**  
**Peugeot Boxer 2007**

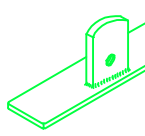

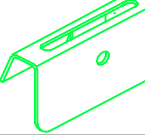
 <b>6x</b>	 <b>6x</b>	 <b>6x</b>
 <b>6x</b>	 <b>12x</b>	 <b>6x</b>
 <b>6x</b>	 <b>12x</b>	 <b>6x</b>
 <b>6x</b>	 <b>6x</b>	 <b>6x</b>
 <b>12x</b>	 <b>12x</b>	
 <b>6x</b>	 <b>3x</b>	

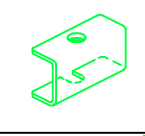
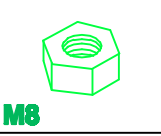
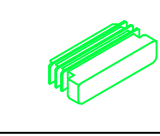
-Bij onduidelijkheden raadpleeg uw leverancier!  
 -Might this not be clear, please contact your supplier!  
 -Bei eventuellen Unklarheiten, bitten wir Sie mit Ihren Lieferanten Kontakt aufzunehmen!  
 -Pour plus de renseignements consultez votre fournisseur!

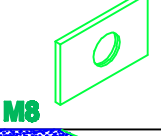
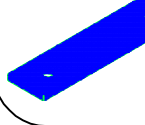
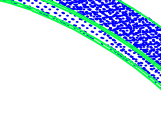
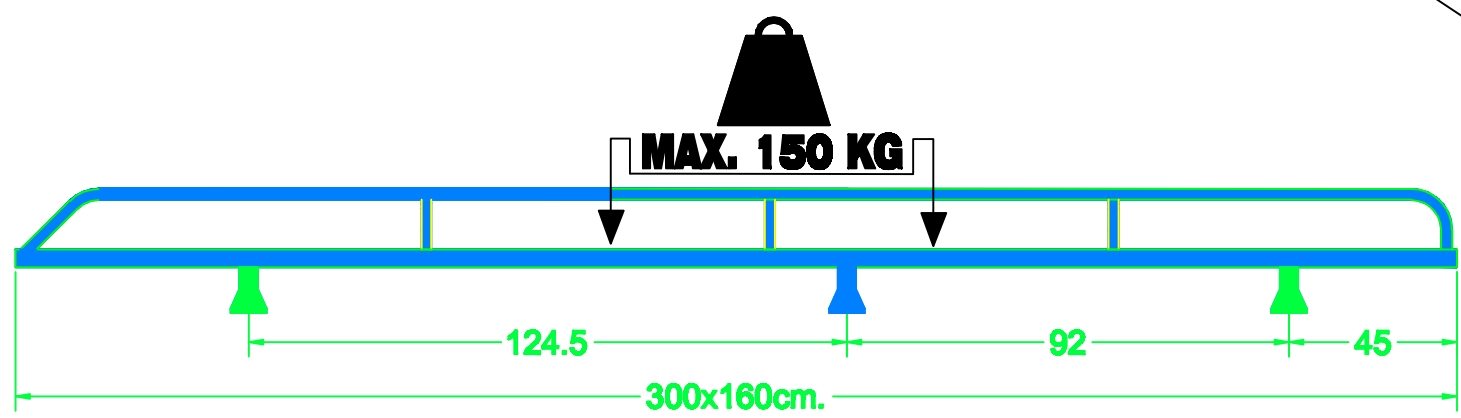
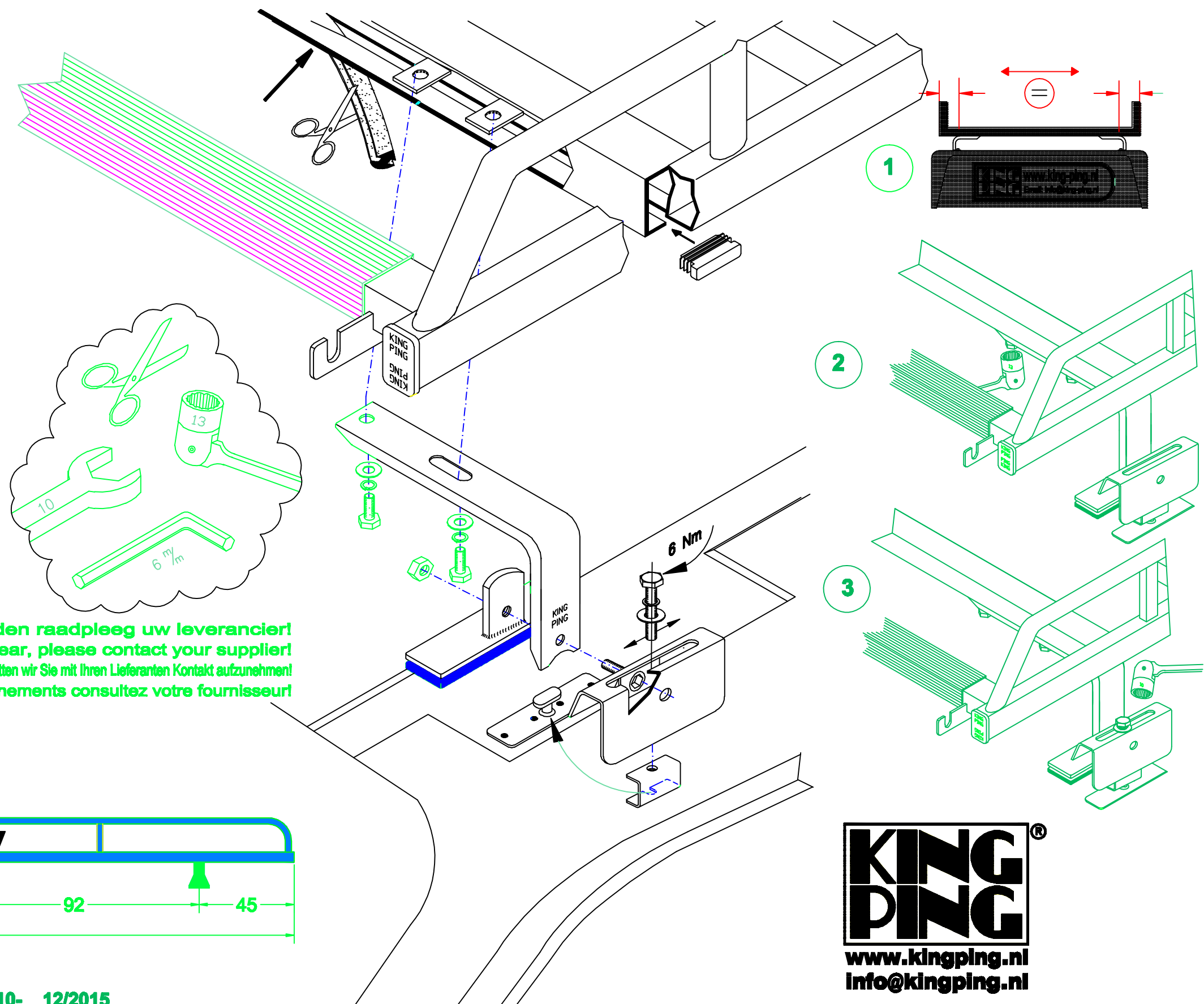

**KING PING®**  
[www.kingping.nl](http://www.kingping.nl)  
[Info@kingping.nl](mailto:Info@kingping.nl)