

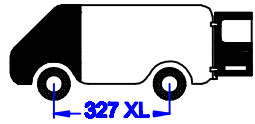

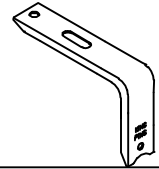





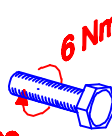

Citroën Jumpy TYPE XL 2016
Peugeot Expert LONG 2016
Toyota Pro Ace LONG WORKER 2016
 300x141cm. L2 H1

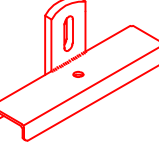
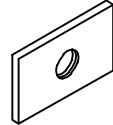

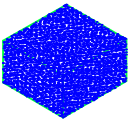
 8x	 24x M8x25	 6x M6x20	 1x
 8x	 24x M8	 6x M6	
 16x	 16x 3xD M8	 6x 2xD M6	
 8x	 24x M8	 6x M6	

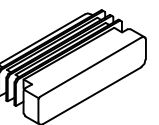

-Bij onduidelijkheden raadpleeg uw leverancier!
 -Might this not be clear, please contact your supplier!
 -Bei eventuellen Unklarheiten, bitten wir Sie mit Ihren Lieferanten Kontakt aufzunehmen!
 -Pour plus de renseignements consultez votre fournisseur!

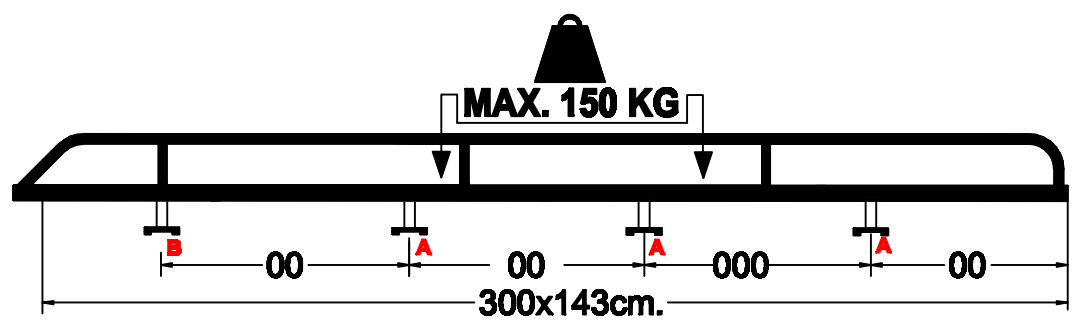

3002 ALUPEL2XLD / ALUCJL2XLD / ALUTPL2XLD 17/08/2016

