

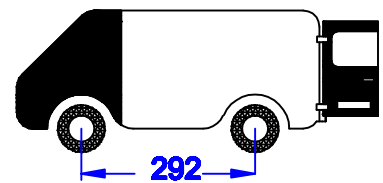

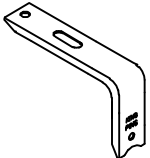







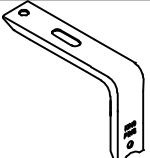
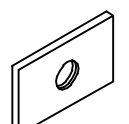

**Citroën Jumpy** TYPE XS 2016  
**Peugeot Expert** COMPACT 2016  
**Toyota Pro Ace** COMPACT 2016

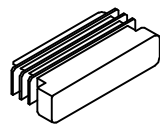
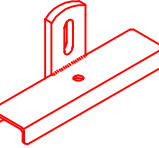

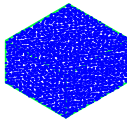
250x141cm. L1 H1

 <b>6x</b>	 <b>24x</b> M8x20	 <b>6x</b> M6x20	 <b>1x</b>
 <b>2x</b>	 <b>24x</b> M8	 * <b>6x</b> M6	 <b>8x</b>
 <b>8x</b>	 <b>16x</b> 3xD M8	 * <b>6x</b> 2xD M6	 <b>16x</b>
	 <b>24x</b> M8	 * <b>6x</b> M6	

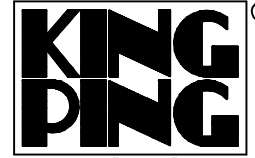

www.kingping.nl  
 info@kingping.nl

- Bij onduidelijkheden raadpleeg uw leverancier!  
 - Might this not be clear, please contact your supplier!  
 - Bei eventuellen Unklarheiten, bitten wir Sie mit Ihren Lieferanten Kontakt aufzunehmen!  
 - Pour plus de renseignements consultez votre fournisseur!

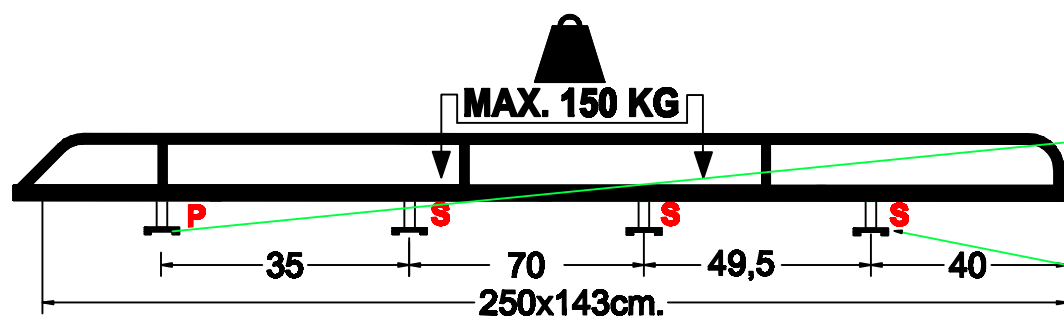

**ALS EERSTE ACHTERSTE  
 STEUN VAST ZETTEN**

**P= ALS LAATSTE  
 ONDER SPANNING ZETTEN  
 ALLEEN AAN DE VOORKANT**

Het zwarte P.V.C.-afdichtprofiel in het railprofiel DRUKKEN om e.v. het fluiten en/of regenopname tegen te gaan.

