

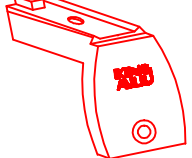





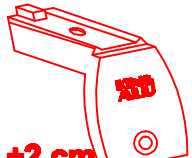

Citroën Jumpy TYPE M 2016
Peugeot Expert STANDAARD 2016
Toyota ProAce WORKER 2016

280x141cm. L2 H1

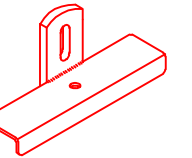

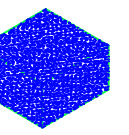
 6x	 8x	 6x
 2x	 16x	 * 6x
 8x	 16x	 * 6x
 16x		 * 6x

MONTAGEFILM KING-ALU IMPERIAAL

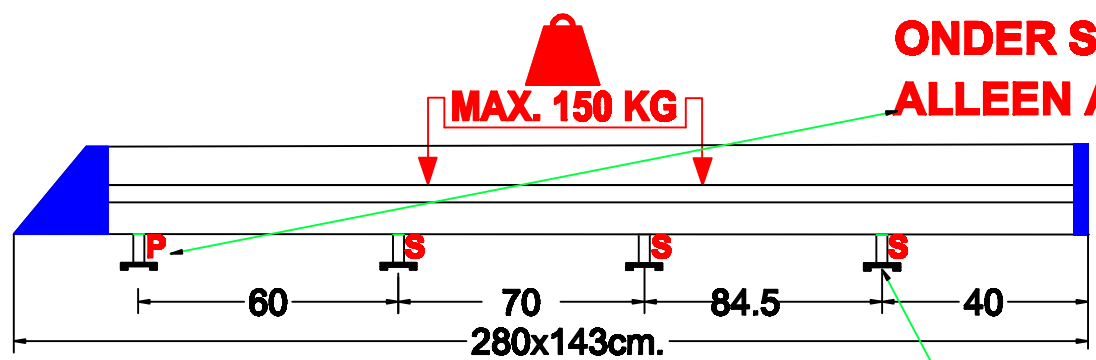

**P= ALS LAATSTE
 ONDER SPANNING ZETTEN
 ALLEEN AAN DE VOORKANT**

**ALS EERSTE ACHTERSTE
 STEUN VAST ZETTEN**

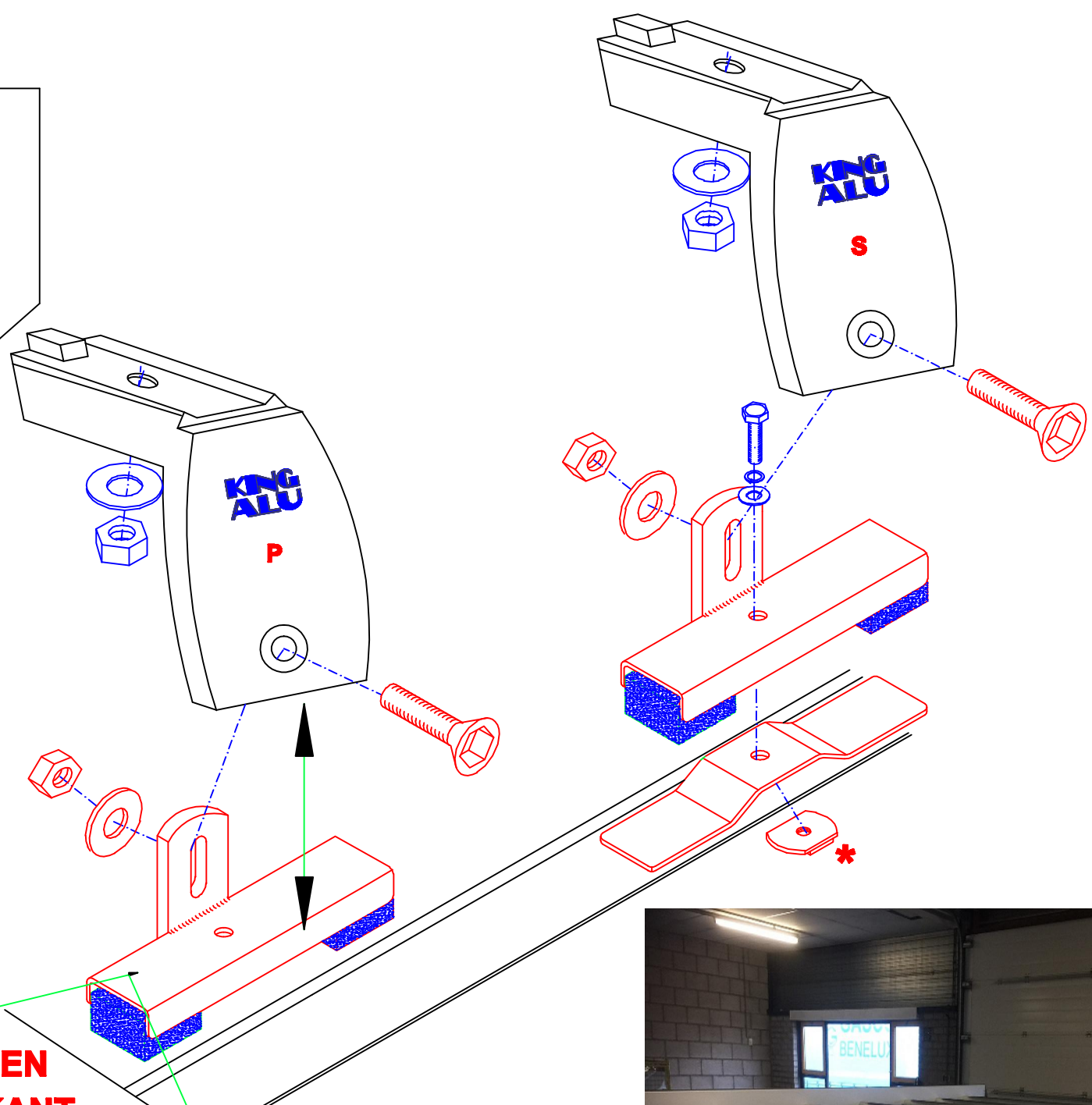

let op deze niet gebruiken

2806 ALUPEL2H1D / ALUCJL2H1D / ALUTPL2H1D 02/2017